

OXFORD MINI COPPER WALL BRACKET

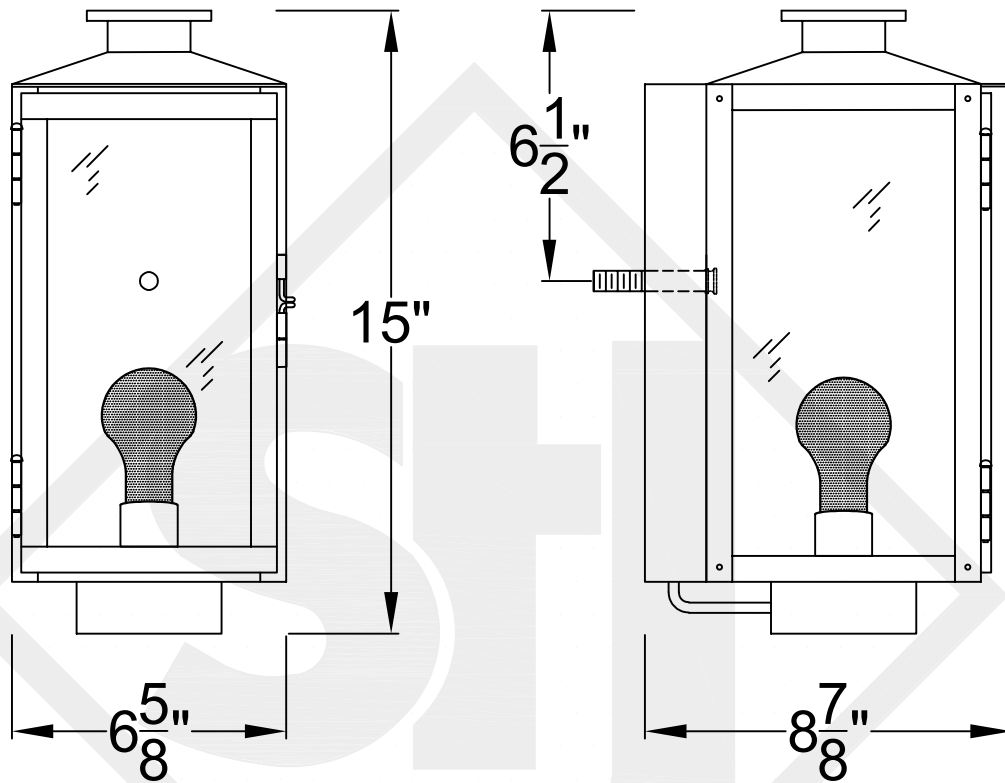

Front View

Side View

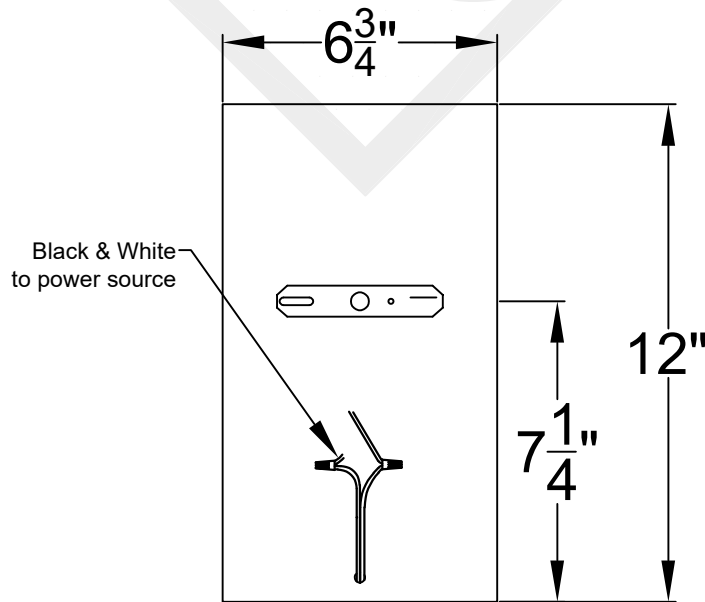

Backplate



St. James
LIGHTING

SCALE: N.T.S.	DRAFT: Y. McCullough
FILE: OXFMINI	APP'D: J. Ragan
JOB: X	DATE: 11/29/23

Lights are handcrafted.
Dimensions may vary by 1/4"

UL Certified
Candelabra- Max 60 Watt Bulb
Edison- Max 660 Watt Bulb

Mini not Available in Gas

OXFORD SMALL COPPER WALL BRACKET

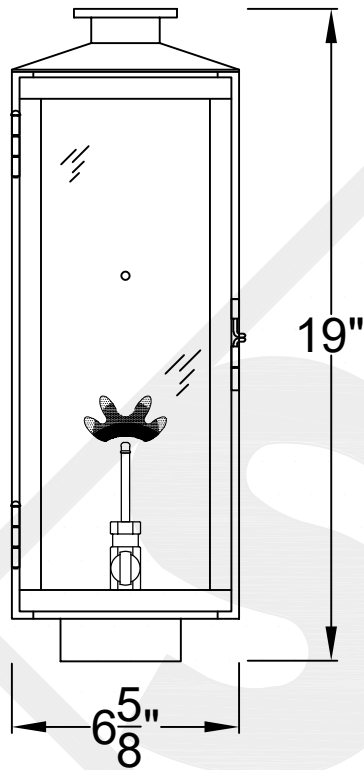

Front View

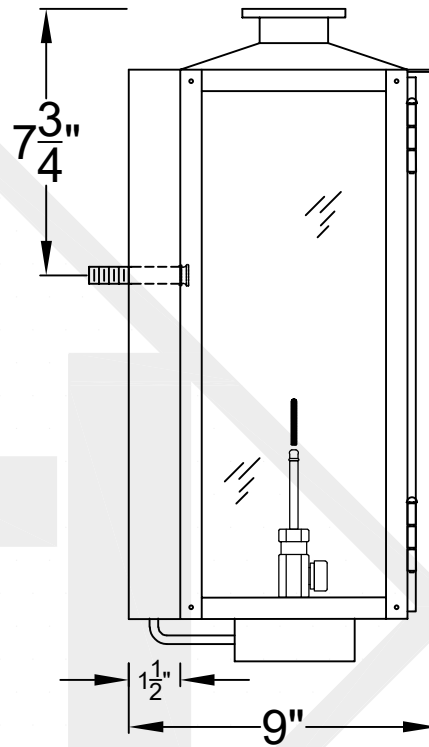

Side View

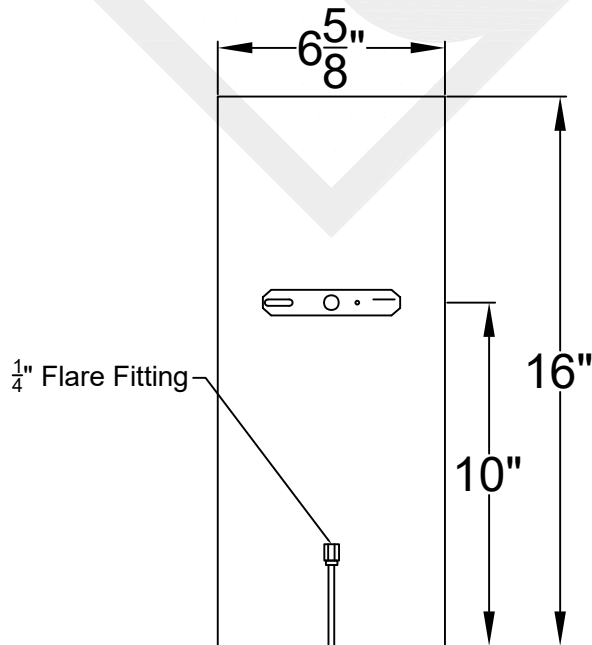

Backplate



St. James
LIGHTING

SCALE: N.T.S.	DRAFT: Y. McCullough
FILE: OXFS	APP'D: J. Ragan
JOB: X	DATE: 11/29/23

Lights are handcrafted.
Dimensions may vary by 1/4"

B.T.U. Rating
Natural Gas: 2730 B.T.U.
Propane: 2080 B.T.U.

OXFORD MEDIUM COPPER WALL BRACKET

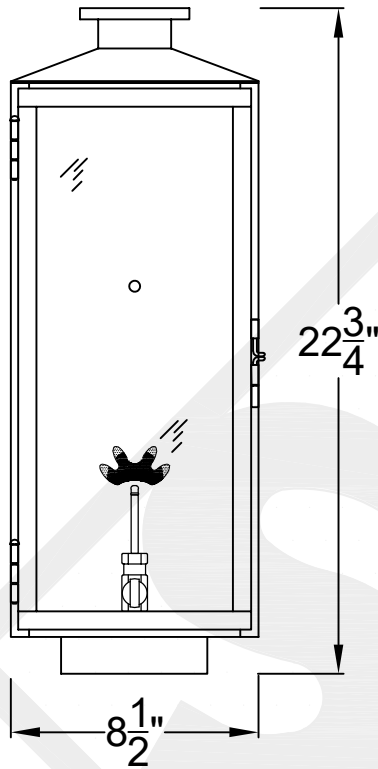

Front View

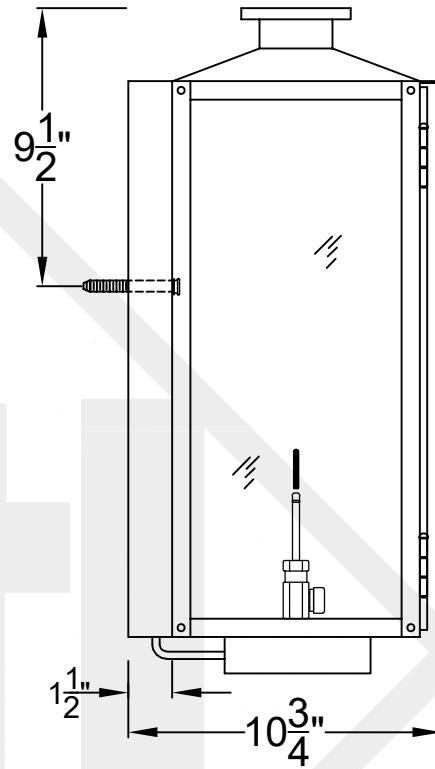

Side View

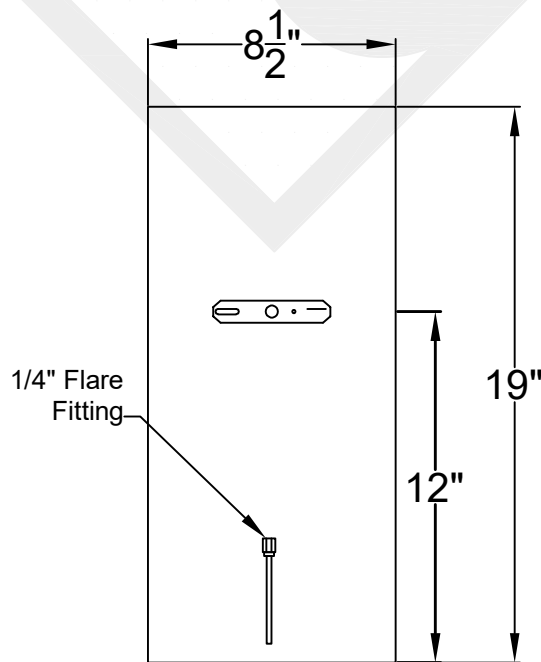

Backplate



St. James
LIGHTING

SCALE: N.T.S.	DRAFT: Y. McCullough
FILE: OXFM	APP'D: J. Ragan
JOB: X	DATE: 11/29/23

Lights are handcrafted.
Dimensions may vary by 1/4"

B.T.U. Rating
Natural Gas: 2730 B.T.U.
Propane: 2080 B.T.U.

OXFORD LARGE COPPER WALL BRACKET

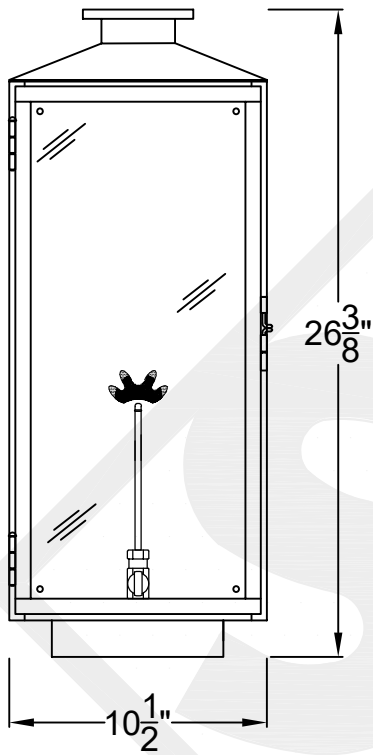

Front View

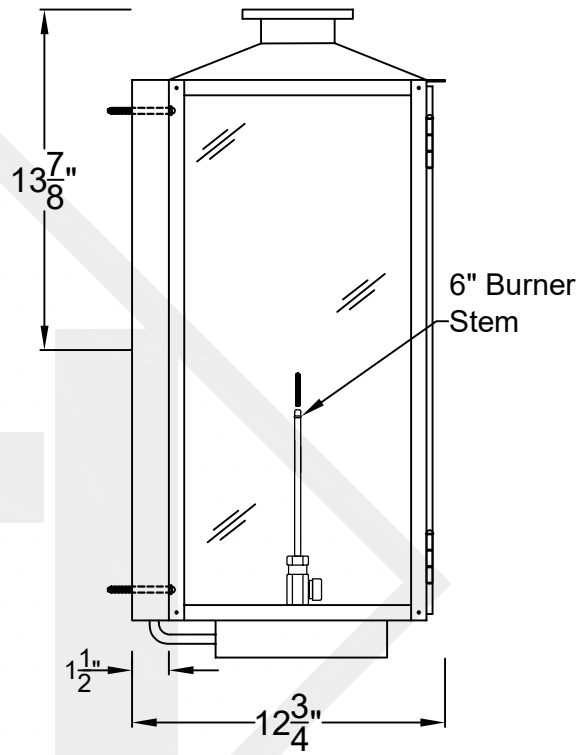

Side View

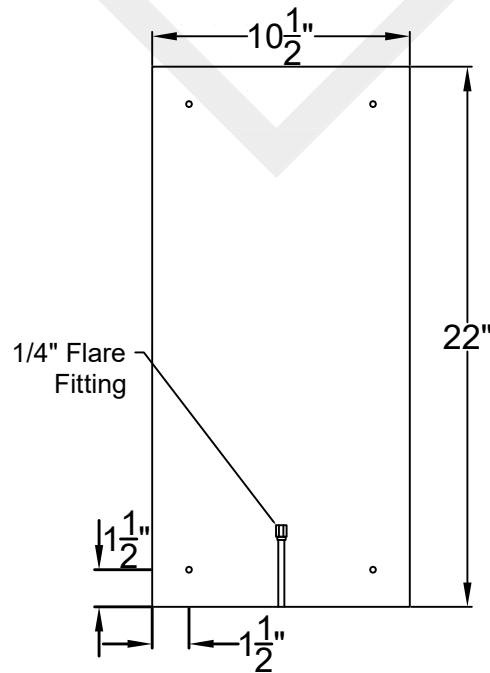

Backplate



St. James
LIGHTING

SCALE: N.T.S.	DRAFT: Y. McCullough
FILE: OXFL	APP'D: J. Ragan
JOB: X	DATE: 12/6/23

Lights are handcrafted.
Dimensions may vary by 1/4"

B.T.U. Rating
Natural Gas: 2730 B.T.U.
Propane: 2080 B.T.U.

OXFORD GRANDE COPPER WALL BRACKET

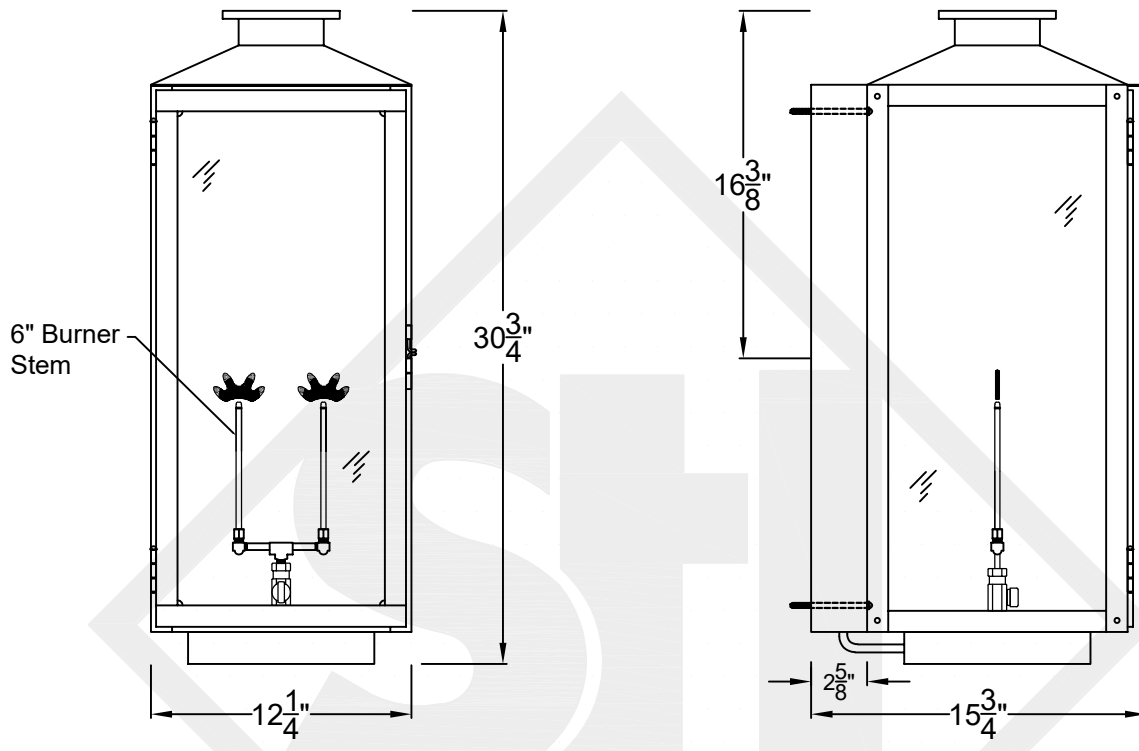

Front View

Side View

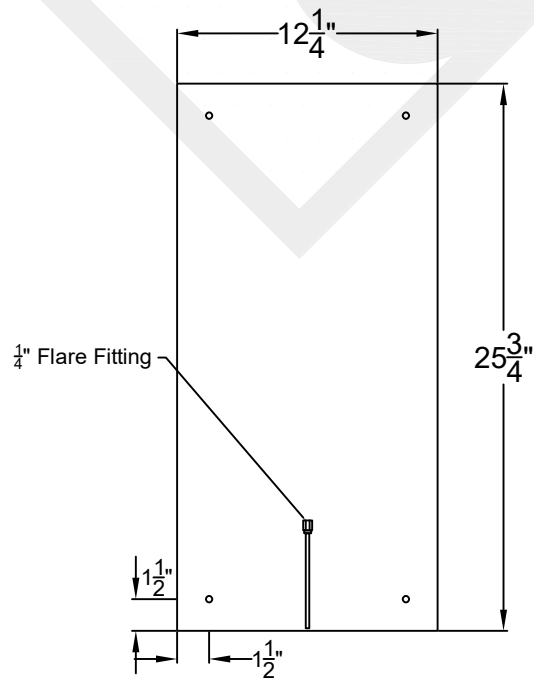

Backplate



St. James
LIGHTING

SCALE: N.T.S.	DRAFT: Y. McCullough
FILE: OXFG	APP'D: J. Ragan
JOB: X	DATE: 12/6/23

Lights are handcrafted.
Dimensions may vary by 1/4"

B.T.U. Rating
Natural Gas: 5460 B.T.U.
Propane: 4160 B.T.U.